

**Flexibility
Simplicity
Efficiency**

The easier way
to singulate
bulk parts



Embrace flexible part feeding solutions for versatility and efficiency



Assembly



Pick & Place



Machine tending



Sorting



Palletizing



Quality inspection

Today the demand for adaptability and precision for most manufacturers is increasing drastically, and the world of industrial automation is seeing a significant shift towards flexible part feeding solutions. High-mix and low-volume manufacturing scenarios along with intense quality standards are becoming more and more common. This dynamic poses unique challenges for system integrators, who are tasked with ensuring that their client's production lines are versatile and efficient.

Normally traditional feeding systems, such as bowl and linear feeders, have a limitation for system integrators and manufacturers trying to get a solution turned around in a timely manner. These traditional part feeding technologies often struggle to handle a wide range of part types and sizes.

Moreover, the time and cost associated with adjusting these systems to new production requirements can be prohibitive, inhibiting operational agility and negatively impacting overall project efficiency.

Unbulk your various components easily

This is where Asyriil's flexible feeding solution comes in. The patented 3-axis vibration technology enables our Asycube flexible feeder to handle parts of different sizes and geometries, offering an effective solution to the challenges that you frequently face. Accommodating component sizes ranging from 0.1 to 150 mm, Asycube feeders offer unrivalled versatility for processes, such as assembly, kit creation, machine tending or sorting, where there is a need to separate parts delivered in bulk.

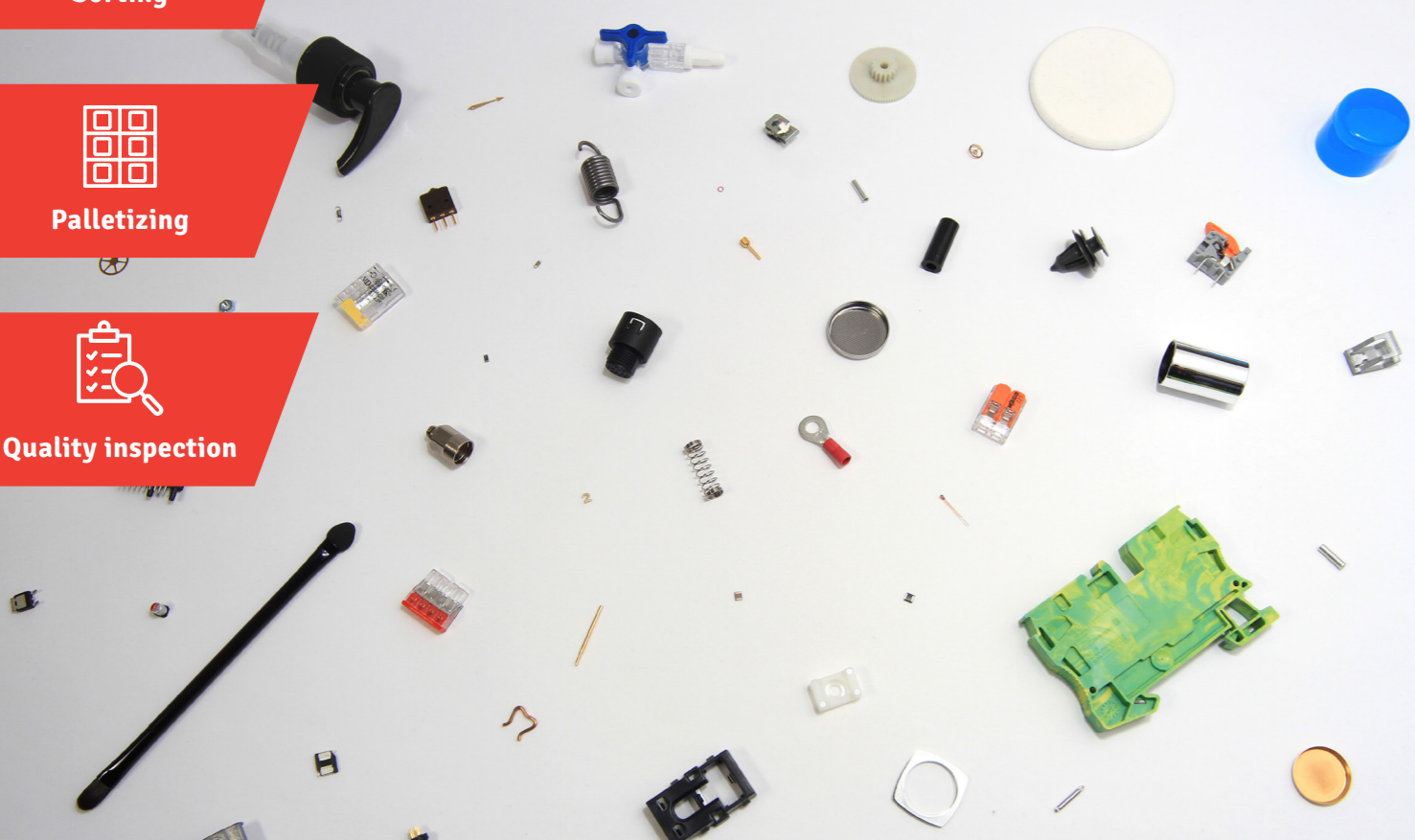

Experts in flexible feeding systems

Technological leader in the field of flexible component feeding, Asyriil is an innovating Swiss company with more than 15 years of expertise. Our key competencies and extensive know-how encompass all three sub-domains of modern part feeding systems: vibration technology, industrial vision and precision robotics. Thanks to our cutting-edge technology, industry players in Europe, America and Asia gain competitive advantages and achieve a fast return on investment.

Companies from various industries such as automotive, cosmetics, medical, life sciences, electronics, semi-conductors, watch and jewelry trust us. With our innovative mindset and Swiss precision, we continuously prepare for the next-generation automation challenges. Guaranteeing you high-quality products, our headquarters in Switzerland comprise R&D and production. We also have subsidiaries located in the USA, Germany, Japan and Singapore and ensure you a global coverage with a reliable network of over 50 distributors in 35 countries.



Automotive



Consumer goods



Medical & Life sciences

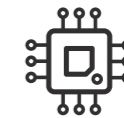

Electronic & Semiconductors



Watch industry & Jewelry



Innovative and high-performance solution

Founded in 2007, Asyriil created a revolutionary feeding solution for the Swiss watch industry. Used in the watch movements, the gemstones required precise placement before being palletized for a polishing machine. This process was previously carried out by hand, and Asyriil flexible feeder enabled the watch industry to fully automate it.

The knowledge gained from this experience has enabled us to develop efficient flexible feeding applications across all industries and to provide you with the best guidance for the automation of manual processes. Our technical training courses offer you practical insights into the implementation of processes, and our support service is at your disposal to meet your requirements thanks to feasibility studies.

Plug and play solution for a simple integration with any type of robot

Asyriil's flexible feeding solution consists of the Asyfill smart hopper, the Asycube flexible feeder and the EYE+ smart control system with integrated vision. This complete and compact solution allows you to gain efficiency in feeding, separating and orientating parts ranging in size from 0.1 to 150 mm and make them easier to pick up by a robot.

The entire application managed by the EYE+ control system

An intuitive and user-friendly interface, the EYE+ smart control system locates the parts using vision and transmits pick-up coordinates to the robot. While managing Asyfill hopper and Asycube feeder, our system identifies the correct part orientation thanks to Artificial Intelligence. It performs the most efficient vibration sequences for optimal distribution of parts on the platform as well as masters their location and orientation. You can quickly feed a new component or easily undertake series changeover in the EYE+ Studio without any tools or hardware modifications.

A solution for efficient feeding today that will also meet your future needs



EYE+ smart control system with AI-based vision

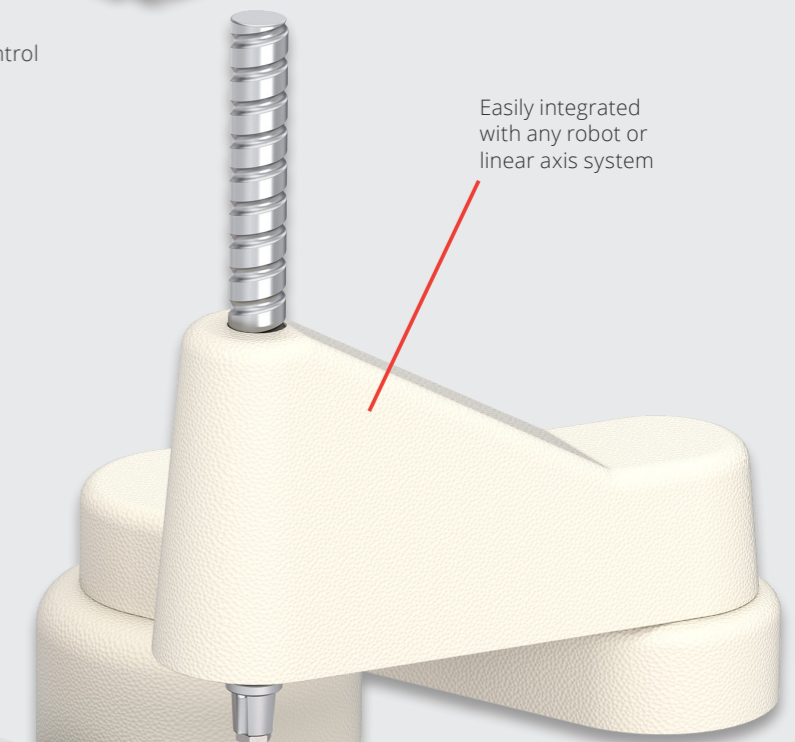

Easily integrated with any robot or linear axis system

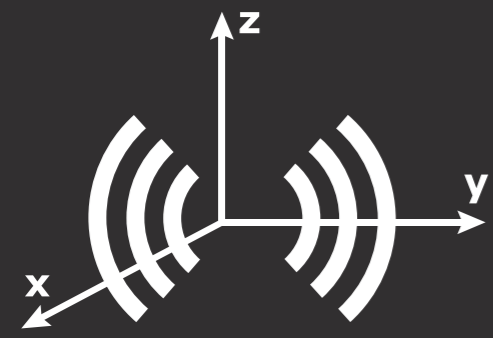

3-Axis Vibration Technology Innovation by asyriil

Successful feeding for 99% of parts even complex geometries and delicate materials

The Asycube feeder moves parts quickly in all directions, eliminates corner and edge accumulation, avoids part recirculation and handles delicate parts smoothly with precise frequency and amplitude control. Asyriil's patented 3-axis vibration technology allows better cycle times and optimal efficiency of your machine even on structured, slotted or perforated platforms for a perfect spread.

Asyfill smart hopper for regulating the number of parts on the Asycube feeder

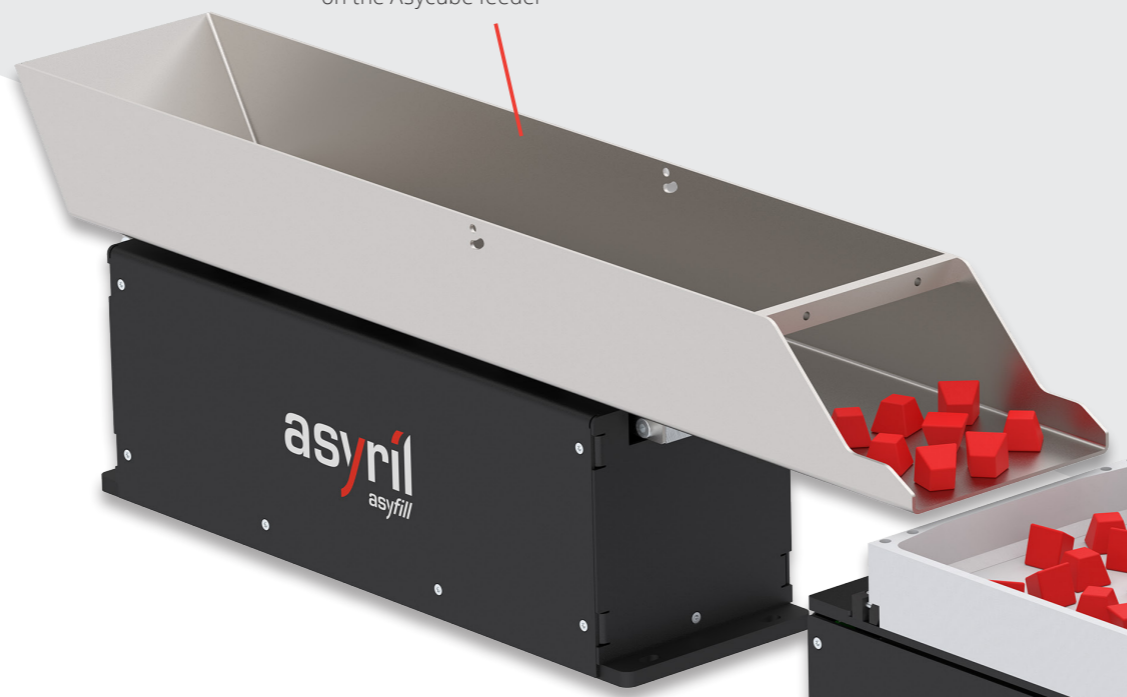

Choose the complete solution with EYE+ control system and Asyfill smart hopper to optimize the performance of your Asycube flexible feeder and therefore improve your cycle time.

Asycube flexible feeder with patented 3-axis vibration technology

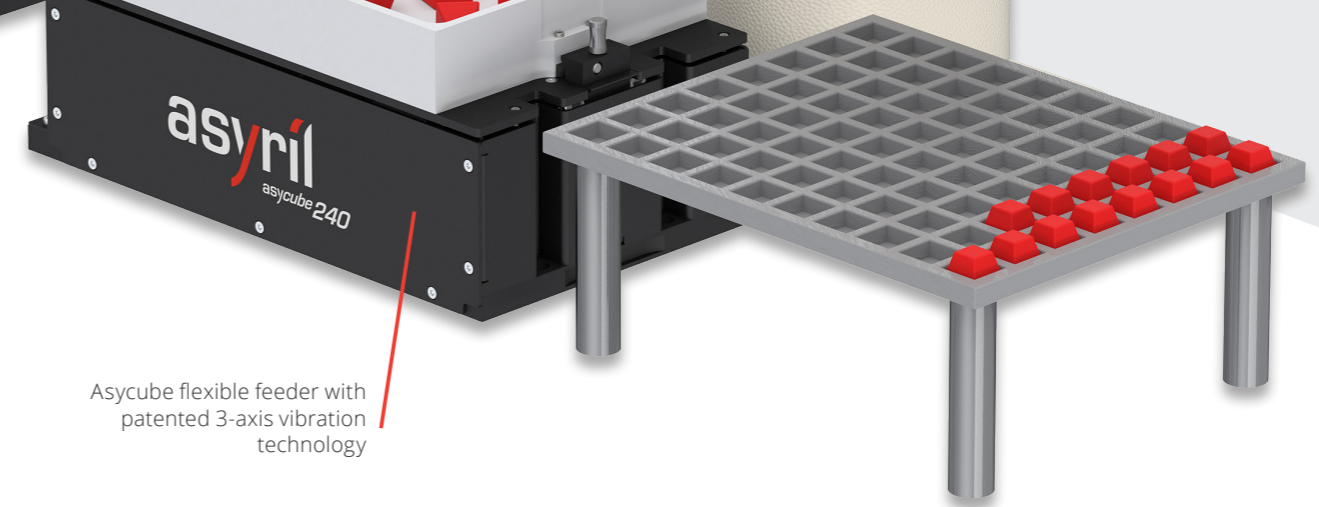

Asyfill smart hopper specifically designed for flexible feeding

Asyfill benefits

- Constant regulation of parts distributed onto the Asycube feeder
- Simple integration
- Amplitude set directly in Asycube Studio or EYE+ Studio
- Compact solution without external controller
- International compatibility with 24 VDC operation

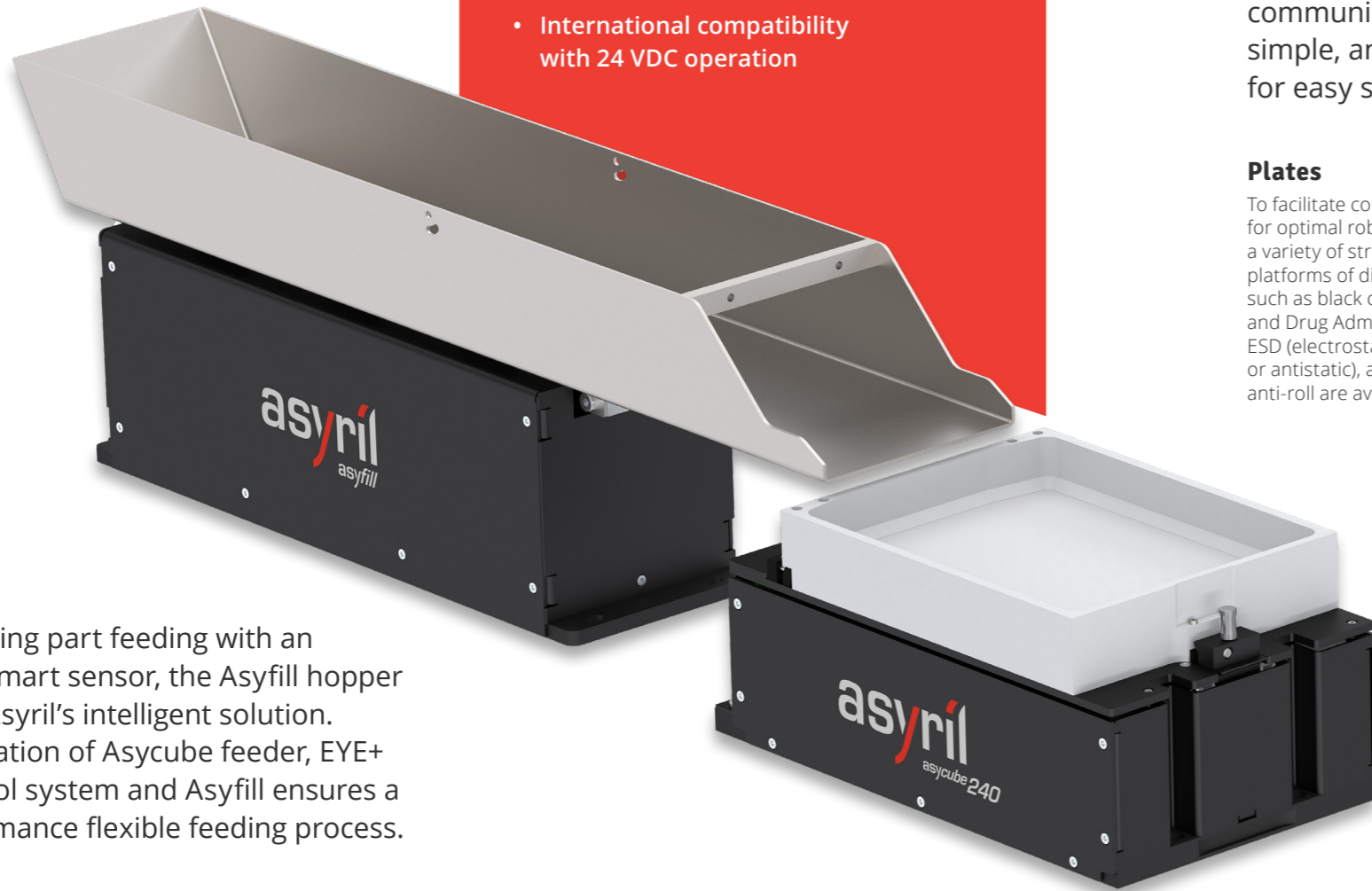

Revolutionizing part feeding with an integrated smart sensor, the Asyfill hopper completes Asyriil's intelligent solution. The combination of Asycube feeder, EYE+ smart control system and Asyfill ensures a high-performance flexible feeding process.

Asycube flexible feeder to feed all your parts

Developed with an innovative and patented technology, the Asycube feeder offers an efficient solution to singulate bulk parts with a small footprint. Asyriil's flexible feeders are compatible with all robots and PLCs thanks to TCP/IP and Modbus TCP communication. Full integration remains simple, and various plugins are available for easy system integration.

Multi-feeding

Increasing efficiency, the multi-feeding option allows to handle different parts on the same Asycube separated by a mechanical barrier. Each part is fed from a different hopper. It will reduce the footprint in your application and require less hardware.

Multi-model

Used for sorting applications, the multi-model allows 6 different orientations of the same part or different parts to be distinguished, all fed from a single hopper. The number of available parts is increased, therefore improving cycle times.



Plates

To facilitate correct orientation for optimal robot part gripping, a variety of structured platforms of different types such as black colour, FDA (Food and Drug Administration), ESD (electrostatic discharge or antistatic), anti-stick and anti-roll are available.

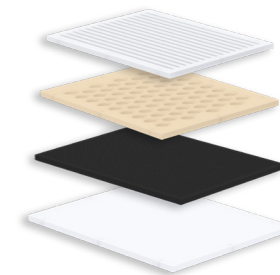

Purge

Thanks to the combination of the quick change platform mechanism and the purge option allowing a simple and easy emptying, Asyriil offers an even more flexible and scalable product for a better return on investment.

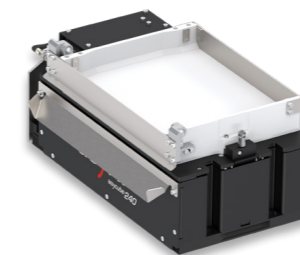

Asycube benefits

- Compatible with 99% of types of parts and geometries
- Short cycle times and reduced production changeover time
- Pre-orientation and gentle separation of components thanks to the patented 3-axis vibration technology
- Easy settings and integration
- Compact and flexible feeder with integrated controller
- Compatible with all types of robots and PLCs
- High-precision products of Swiss quality using voice coil technology

Product range

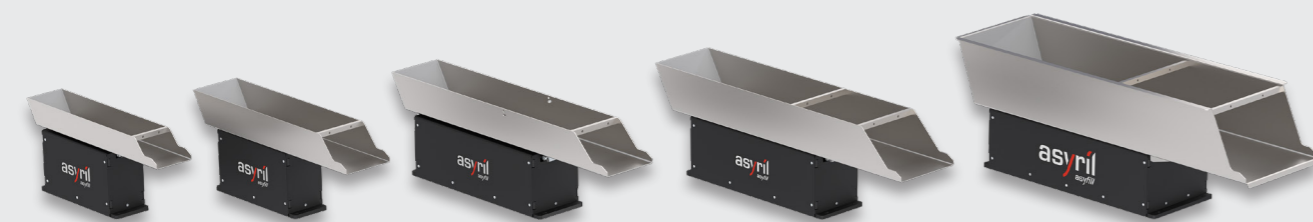

Asyfill S 1L Asyfill S 2L Asyfill M 3L Asyfill M 7L Asyfill L 14L

3-year warranty on Asycube range



Asycube 50 Asycube 80 Asycube 240 Asycube 380 Asycube 530

EYE+ smart control system for efficient production

Composed of a powerful compact controller and a high-resolution camera, the intuitive EYE+ smart control system integrates AI-based algorithms to optimize the performance of your Asycube flexible feeder. EYE+ manages all components of your application including the robot via the EYE+ Studio web-based interface. Thanks to a large number of ready-to-use plugins for robots and fieldbuses such as EtherNet/IP, EtherCAT and PROFINET, you can easily integrate EYE+ into any automation machine.



EYE+ benefits

- Easy to use
- Simple and user-friendly interface without coding
- Easy creation and configuration of recipes in minutes
- Plug and play: quick and intuitive installation, assembly and configuration
- All-in-one: no third-party software or hardware required
- Compatible with all brands of PLCs and industrial robots

20 minutes to deploy EYE+ without any machine vision experience

The set up and use of the EYE+ smart control system ensure flexibility in high-mix and low-volume manufacturing environment and require no previous vision experience. Set up the EYE+ camera and configure your vision recipes easily and only in a few minutes. Just follow the wizard step by step.

1 Camera configuration

Before starting to program a recipe, perform a simple vision calibration. Follow the EYE+ camera configuration wizard. An easy-to-use focus tool saves you time and prevents camera adjustment complications.

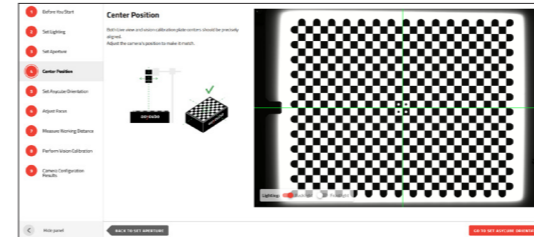

2 Recipe creation



EYE+ acquires several images of all the parts present on the Asycube platform with different exposure times and lighting. Surrounding potential pickable parts by a green rectangle, the system detects potential desired candidates.



Train EYE+ to build a database of pickable parts by simply swiping the correctly oriented candidates in the right column and the non pickable candidates in the left column.

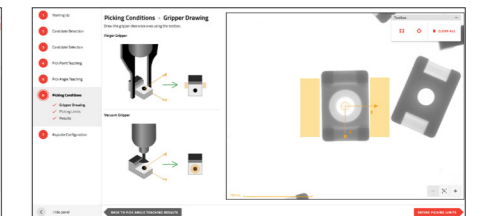

Define the appropriate pick point and pick angles as well as the picking limits where the robot has no risk of collision with the frame of the plate or another object while picking parts.

3 Asycube configuration

Configure the vibrations of the Asycube feeder and Asyfill hopper to be able to perform vibration sequence. Thanks to the intelligent features, EYE+ will then execute the best vibration sequence for Asyfill and Asycube to ensure that the optimum number of pickable parts is available all the time.



4 Hand-eye calibration

Once you have transformed the coordinates of the parts from the vision frame to the robot frame with our practical hand-eye calibration wizard, you can deploy the recipe to production.



5 Production run

A web-based dashboard provides you with the real-time visibility and awareness you need to optimize and seek trends in the production.

Want to know how the Asyriil's complete solution might perform with your components? Request a free test!

Send us your parts, and we will carry out a full feasibility study for you! You will receive a free detailed report on vibration, vision and cycle time, accompanied by video recordings of the feasibility study with your parts.



Product specifications



Asycube 50



Asycube 80



Asycube 240



Asycube 380



Asycube 530

General information						
Part sizes	0.1 - 5 mm ~ 0.004 - 0.2"	3 - 15 mm ~ 0.1 - 0.6"	5 - 40 mm ~ 0.2 - 1.5"	15 - 60 mm ~ 0.6 - 2.4"	30 - 150 mm ~ 1.6 - 6"	
Power supply	24 VDC / 6 A		24 VDC / 8 A	24 VDC / 20 A		
Connection cables	Power, communication and backlight		Power, communication, backlight and input/output			
Configuration software	Asycube Studio (installable on Windows 10 or higher) or EYE+ Studio					
Communication	Ethernet (TCP/IP) and Modbus TCP					
Optional via Gateway	EtherNet/IP, EtherCAT, PROFINET and CC-Link					
Optional via software plugins	ABB, DENSO, FANUC, MITSUBISHI ELECTRIC, STÄUBLI, UNIVERSAL ROBOTS, YAMAHA and YASKAWA					
Options						
Integrated LED backlight	Red, green, blue, white and infrared					
Vibration plates	Flat, holes, grooves, nests, pockets, various materials (ESD, Medical FDA approved) and colors					
Purge	Purge platform with purge box		Right or left purge platform			
Hopper sizes	10 cm ³ or 110 cm ³	160 cm ³	Compatible with Asyfill S and M	Compatible with Asyfill S, M and L		
Dimensions						
Vibration platform	A	34 mm / ~ 1.4"	52 mm / ~ 2.1"	150 mm / ~ 5.9"	254 mm / ~ 10"	370 mm / ~ 14.6"
	B	45 mm / ~ 1.8"	65 mm / ~ 2.6"	195 mm / ~ 7.6"	325 mm / ~ 12.8"	427 mm / ~ 16.8"
Footprint	C	46 mm / ~ 1.8"	65 mm / ~ 2.6"	171 mm / ~ 6.7"	257 mm / ~ 10.1"	374 mm / ~ 14.7"
	D	293 mm / ~ 11.6"	320 mm / ~ 12.6"	300 mm / ~ 11.8"	499 mm / ~ 19.6"	600 mm / ~ 23.7"
	D'	50 mm / ~ 2.0"	50 mm / ~ 2.0"	45 mm / ~ 1.8"	115 mm / ~ 4.5"	115 mm / ~ 4.5"
Maximum height	E	140 mm / ~ 5.5"	140 mm / ~ 5.5"	132 mm / ~ 5.2"	308 mm / ~ 12.1"	328 mm / ~ 12.9"
Pick height	F	110 mm / ~ 4.4"	111 mm / ~ 4.4"	105 mm / ~ 4.1"	245 mm / ~ 9.65"	259 mm / ~ 10.2"
Weight		3.1 kg	3.7 kg	7.8 kg	20 kg	31 kg

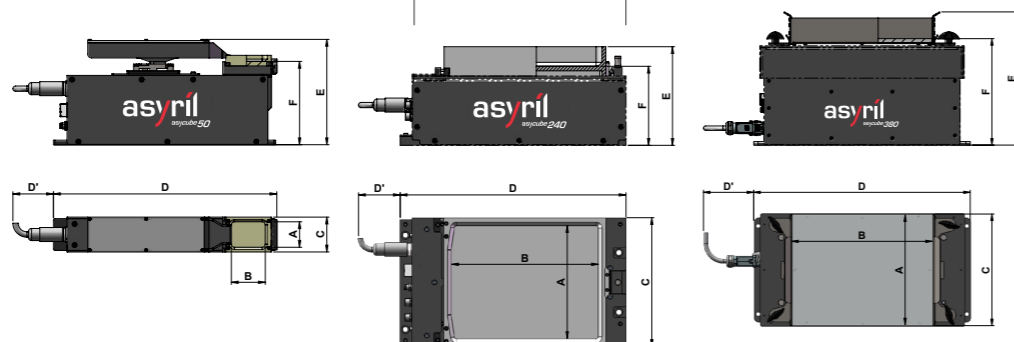

	Asyfill S 1L	Asyfill S 2L	Asyfill M 3L	Asyfill M 7L	Asyfill L 14 L	
General information						
Container volume	1L	2L	3L	7L	14L	
Maximal admissible load	2 kg		12 kg		20 kg	
Power supply	24 VDC / 5 A		24 VDC / 10 A			
Connection cables	Power, communication and input					
Communication	Via the Asycube Analog interface					
Container material	Stainless steel 1.4301					
Pairing with Asycube	Asycube 240, 380 and 530				Asycube 380 and 530	
Dimensions						
Overall dimensions	A	88 mm / ~ 3.5"	112 mm / ~ 4.4"	124 mm / ~ 4.9"	159 mm / ~ 6.3"	254 mm / ~ 10.0"
	B	433 mm / ~ 17.0"	484 mm / ~ 19.1"	657 mm / ~ 25.9"	705 mm / ~ 27.8"	794 mm / ~ 31.3"
Total height	C	193 mm / ~ 7.6"	208 mm / ~ 8.2"	212 mm / ~ 8.4"	231 mm / ~ 9.1"	276 mm / ~ 10.9"
Weight	4.2 kg		4.2 kg	11.6 kg	11.6 kg	19.1 kg

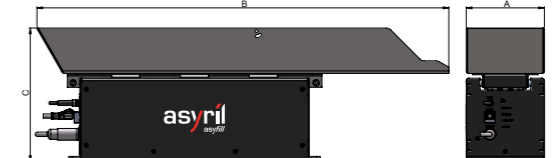

EYE+

General information	
All in-one kit	Controller, camera, optics, calibration plate and power cable
Power supply	24 VDC / 6.5 A max
Ethernet	4x Gigabit Ethernet (PoE for the camera)
Software	EYE+ Studio
Camera	High resolution (6.3 MP)
Communication	
Ethernet (TCP/IP)	
Optional Fieldbus interface modules	EtherNet/IP, EtherCAT and PROFINET
Optional via software plugins	ABB, DENSO, EPSON, FANUC, KUKA, MITSUBISHI ELECTRIC, STÄUBLI, UNIVERSAL ROBOTS, YAMAHA and YASKAWA
Options	
Frontlight	Various colors available
Additional cables	Ethernet cable to PLC or robot, Ethernet cable for EYE+ camera and Ethernet cable for Asycube
Licenses	Multi-feeding and multi-model
Dimensions	
EYE+ controller	A
	B
	C
Weight	1.3 kg

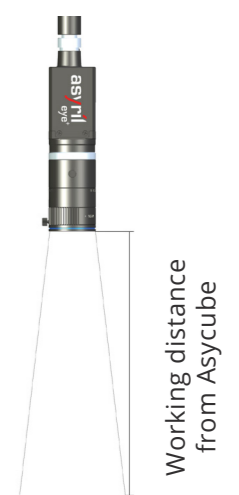
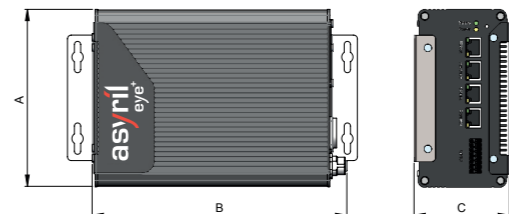

Working distance

Near working distance	
Asycube 50	390 mm / ~ 15.4"
Asycube 80	580 mm / ~ 22.8"
Asycube 240	790 mm / ~ 31.1"
Asycube 380	810 mm / ~ 31.9"
Asycube 530	900 mm / ~ 35.4"
Far working distance	
Asycube 50	560 mm / ~ 22.1"
Asycube 80	850 mm / ~ 33.5"
Asycube 240	1070 mm / ~ 42.1"
Asycube 380	1260 mm / ~ 49.6"
Asycube 530	1260 mm / ~ 49.6"



Close to you all over the world

Switzerland

Headquarters, R&D and production

Asyri SA
Switzerland
+41 26 420 42 42
info@asyri.com

Germany **Technical center**

Asyri GmbH
+49 151 58405941
info.de@asyri.com

USA **Technical center**

Asyri US Inc.
+1 612 294-6886
info.us@asyri.com

Japan **Technical center**

Asyri K.K.
+81 (45) 479-9393
info.jp@asyri.com

Singapore **Sales office**

**Asyri Singapore
PTE. LTD.**
+65 98361678
info.sg@asyri.com



www.asyri.com

#asyri  

